

FILTERMIST OIL MIST FILTER S800



TECHNICAL SPECIFICATION

Airflow (m ³ /h)	800 @ 50Hz 950 @ 60Hz
Motor	0.55kW 50Hz 200v, 220v, 380v, 400v 0.55kW 60Hz 200v, 220v, 230v, 440v, 460v, 480v
A (mm)	325
B (mm)	435
C (mm)	35
D (mm)	148
Weight	15 kg
Noise Level	67 dB(A)

DESCRIPTION

Filtermist S800 units efficiently remove oil & coolant mist, fume and steam in a various amount of manufacturing operations around the world.

Can be directly connected to the machining centre or fixed on a stand with easy access for maintenance.

DIMENSIONS

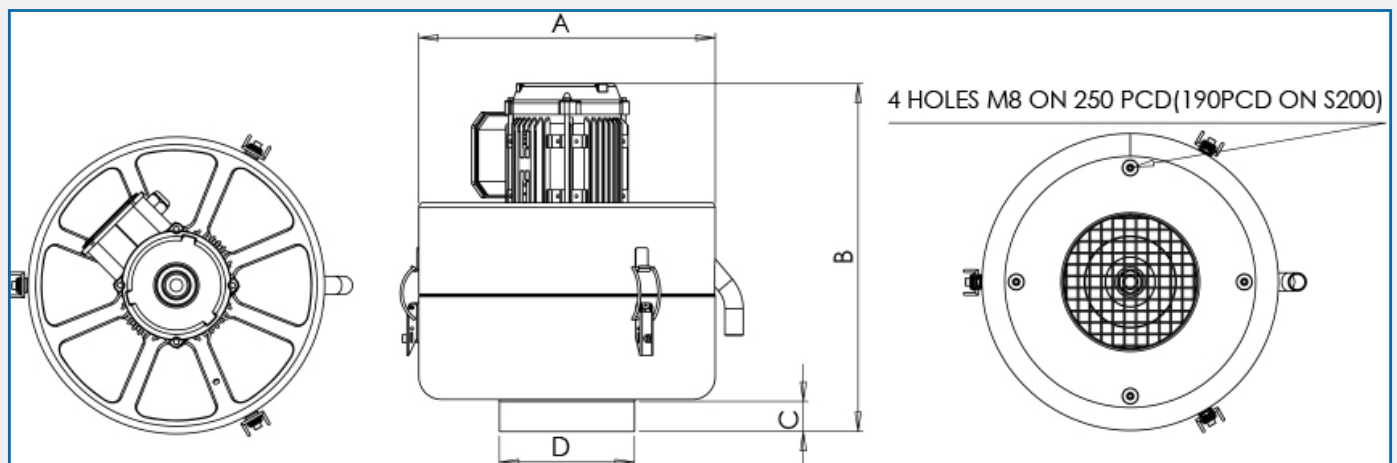

AES OFFER INSTALLATION AND SERVICE SUPPORT FOR ALL EQUIPMENT